

REVISION RECORD			
REV.	CONTENT	MOD.	DATE
△0	新发行		

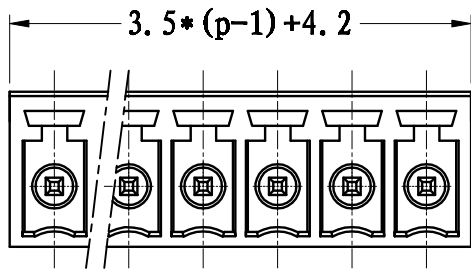

**NOTES:**  
 Pitch : 3.5mm  
 Rated Voltage : 300V  
 Rated Current : 8 A  
 Withstand Voltage :  
 AC2500V for 1 minute  
 Insulation Resistance :  
 5MΩ / DC500V  
 Using Temperature Range :  
 -40℃ ~ +105℃

**技术要求:**  
 间距: 3.5mm  
 额定电压: 300V  
 额定电流: 8A  
 耐电压值: AC2500V/min  
 绝缘阻抗: 5MΩ/DC500V  
 使用条件: -40℃~+105℃

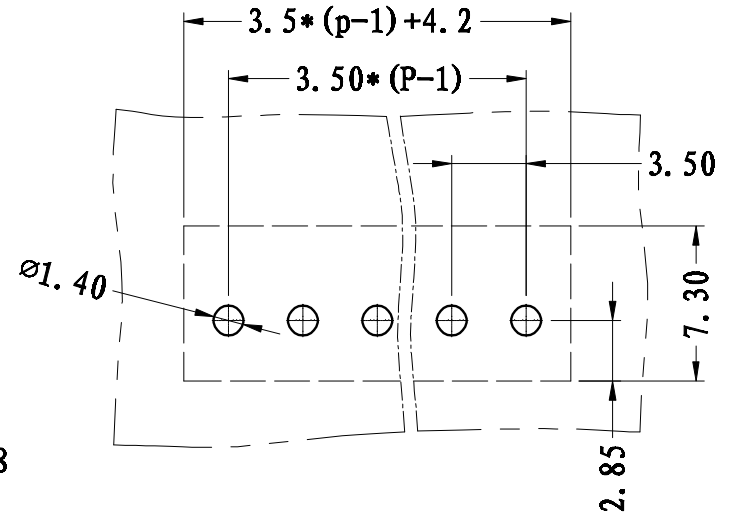
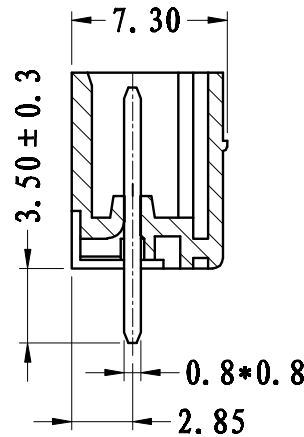
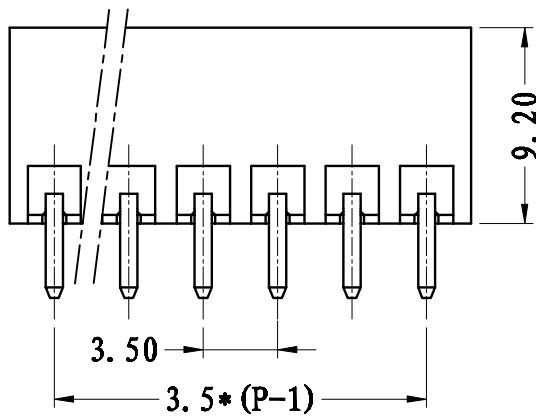

	pitch dimension			Nominal dimension					— □ ○
	over 0 to 6	over 6 to 10	over 10 to 24	over 0 to 30	over 30 to 60	over 60 to 100	over 100 to 150		
variable range	0	6	10	0	30	60	100	150	□ ○
Tolerance	±0.1	±0.15	±0.25	±0.2	±0.3	±0.5	±0.7	±1.0	0.05/10

2	LZ1-3.81-直针	1003B0001AV	P	黄铜	镀锡
1	LZ1-3.5-本体	1025A0YXXAV	1	PA66	
NO.	NAME OF PART	NO. OF PART	QTY	MATERIAL	NOTES
DES.	ARKINE	DATE	11-07-5	UNITS	MM
CHK.	DATE	SIZE	A4	THIRD ANGLE PROJECTION	SHEET
APP.	DATE	SCALE	1:1	DWG NO.	SP-2-1025002
 <b>上海联捷电气有限公司</b> Shanghai Blinker Electric C.O.,LTD				TITLE	LZ1V-3.5-XXP-1Y-00A LZ1V-3.5-成品
					REV: V0
					1 of 1

REVISION		RECORD	
REV.	CONTENT	MOD.	DATE
△	初版发行		

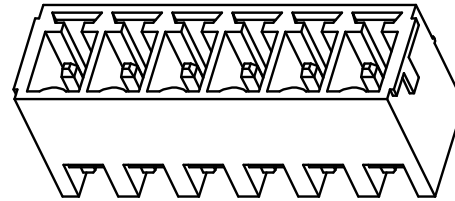
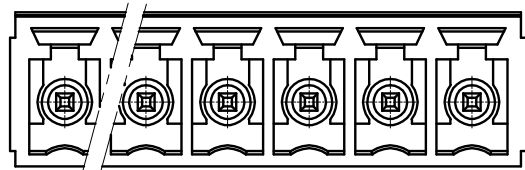

NOTES:  
 Pitch: 3.81mm  
 Rated Voltage: 300V  
 Rated Current: 8 A  
 Withstand Voltage:  
 AC2500V for 1 minute  
 Insulation Resistance:  
 500MΩ / DC500V  
 Using Temperature Range:  
 -40℃ ~ +105℃

技术要求:  
 间距: 3.81mm  
 额定电压: 300V  
 额定电流: 8A  
 耐电压值: AC2500V/min  
 绝缘阻抗: 500MΩ/DC500V  
 使用条件: -40℃~+105℃

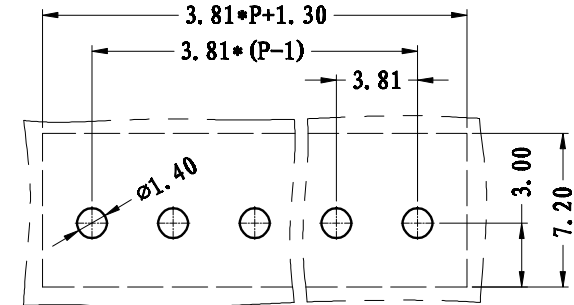
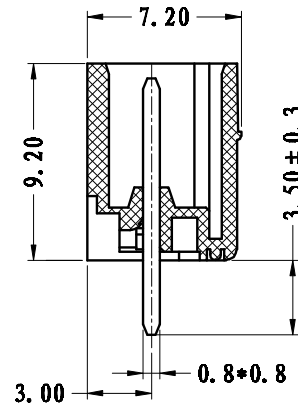
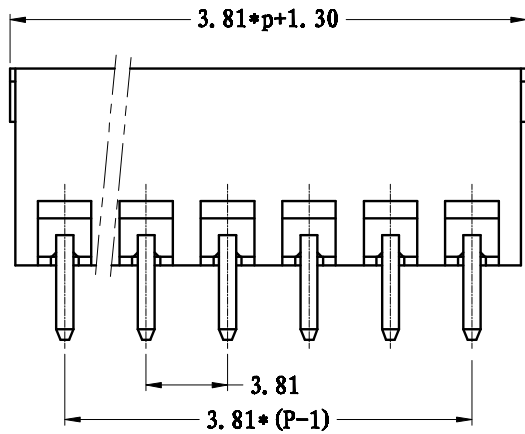

	pitch dimension			Nominal dimension					— □ ○
	over	over	over	over	over	over	over	over	
variable range	0 to 6	6 to 10	10 to 24	0 to 30	30 to 60	60 to 100	100 to 150		
Tolerance	±0.1	±0.15	±0.25	±0.2	±0.3	±0.5	±0.7	±1.0	0.05/10

2	LZ1-3.81-直针	1003B0001AV	P	黄铜	镀雾锡
1	LZ1-3.81-本体	1003A0YXXAV	1	PA66	
NO.	NAME OF PART	NO. OF PART	Q'TY	MATERIAL	NOTES
DES.	ARKINE	DATE	2010/7/21	UNITS	MM
CHK.		DATE		SIZE	A4
APP.		DATE		SCALE	1:1
				DWG NO.	SP-2-1003003
				REV.	Y0
<b>上海联捷电气有限公司</b> Shanghai Blinker Electric C.O.,LTD				TITLE	LZ1V-3.81-XP-1Y-00A LZ1V-3.81-成品